



ITEM #0774382

LED PLUG IN UNDER CABINET BAR

MODEL #UC1051-AL3-09LF0-U

Français p. 7

Español p. 13

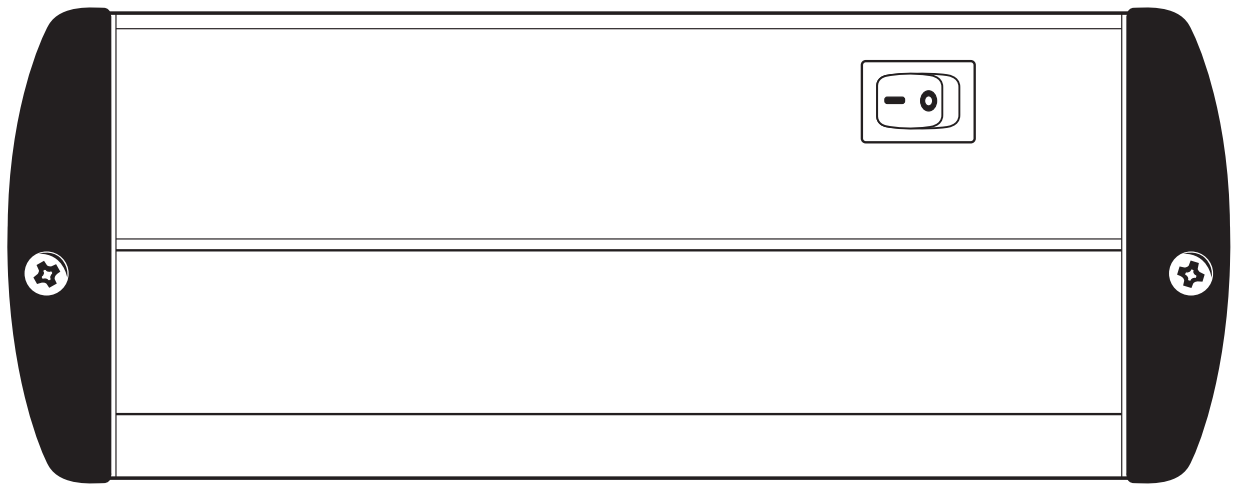

ATTACH YOUR RECEIPT HERE

Serial Number: _____ Purchase Date: _____



Questions, problems, missing parts? Contact the customer service department at 1-866-994-4148, 8 a.m. - 6 p.m., EST, Monday - Thursday, 8 a.m. - 5 p.m., EST, Friday.

PACKAGE CONTENTS

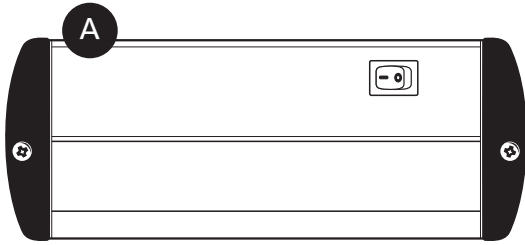

PART	DESCRIPTION	QUANTITY
A	Fixture	1
B	Power Cord	1
C	Linking Cord	1

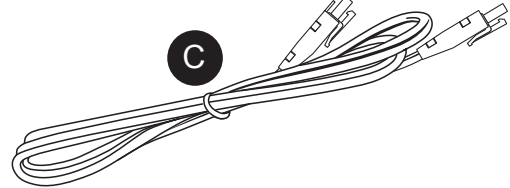
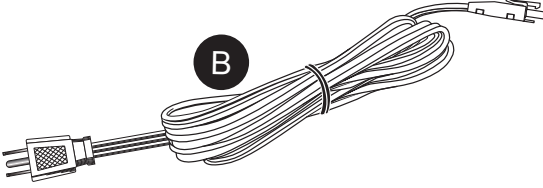

HARDWARE CONTENTS (shown actual size)

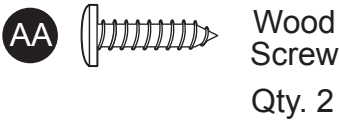

SAFETY INFORMATION

WARNING

- Please read and understand this entire manual before attempting to assemble, operate or install the product.

CAUTION

- **This fixture is dimmable with a forward phase electronic dimmer.** Dimmers tested to be compatible with this fixture are the Lutron: Diva® C•L™: DVWCL-153P or DVCL-153P, Lumea® C•L™: LGCL-153P, and Toggler® C•L™: TGCL-153P8. If unfamiliar with electrical installations, it is recommended a qualified electrician do the installation.
- This device complies with Part 15 of the FCC rules. Operation is subject to the following two conditions: (1) This device may not cause harmful interference, and (2) this device must accept any interference received, including interference that may cause undesired operation.

IMPORTANT SAFETY INSTRUCTIONS

This unit has a grounded plug as a safety feature. This plug will fit in a grounded outlet only one way. If it still does not fit, contact a qualified electrician. Never use with an extension cord unless the plug can be fully inserted. Do NOT attempt to override this feature.

Please note that the 9 in. size of this fixture cannot be direct wired due to space constraints inside the wiring compartment. The 9 in. size can only be plugged in using the included power cord, or connected to another fixture using the linking cord.

WARNING: To reduce the risk of FIRE, ELECTRIC SHOCK, OR INJURY TO PERSONS:

1. For **INDOOR USE ONLY**.
2. Not intended for installation in plastic cabinets.
3. The mounting surface should be flat and sturdy enough to support the fixture.
4. Do **NOT** mount the fixture to cabinets having a material thickness less than 1/4 in.
5. Not intended for recessed installation in ceilings or soffits.
6. Do **NOT** use in wet locations.
7. Do **NOT** use for illumination of aquariums.
8. Do **NOT** mount over sinks or stoves.
9. Do **NOT** touch, operate, or install fixture while in contact with water.
10. Do not remove the protective LED lens or touch the LEDs at any time.
11. Use a soft cloth to clean the diffuser and/or fixture.

PLUG-IN/LINKING SAFETY INFORMATION:

12. Do **NOT** attempt to install while plugged in.

SAFETY INFORMATION

13. Use only insulated staples or plastic ties to secure the power or linking cords.
14. The National Electrical Code (NEC) does not permit cords to be concealed where damage to insulation may go unnoticed. To prevent fire danger, do not run cord behind walls, ceilings, soffits, cabinets, or similar permanent structures where it may be inaccessible for examination. Cords should be visually examined periodically and immediately replaced when any damage is noted.
15. Do not use an extension cord. Use power strip with integral overcurrent protection to supply power to the fixture.
16. The total wattage of ALL the fixtures linked together in one chain should NOT exceed 360 watts. Exceeding the total wattage will result in a hazardous situation. Fixture wattage can be found on back of fixture.

IMPORTANT: These LED light heads use light emitting diodes to provide light. LEDs are electronic semiconductors and do not have a filament that can burn out like an ordinary light bulb. As such, the LED light heads can last up to 50,000 hours when used intermittently, and therefore, never need replacing.

SAVE THESE INSTRUCTIONS IN A LOCATION CLOSE TO THE LIGHT FIXTURE TO REFER TO THEM AT A LATER TIME. Before installation, plug in fixture to a 120 V, 60 Hz electrical outlet to check for proper operation. Then, unplug and begin the installation.

PREPARATION

Before beginning assembly of product, make sure all parts are present. Compare parts with package contents list and hardware contents list. If any part is missing or damaged, do not attempt to assemble the product.

Estimated Assembly Time: 25 minutes

Tools required for assembly (not included): Phillips screwdriver and flathead screwdriver.

MOUNTING OPTIONS

There are two methods to mount the fixture to a cabinet. The first is the **EASY MOUNTING INSTALLATION** method that uses the pre-installed screws located at both ends of the fixture. The second is the **TRADITIONAL MOUNTING INSTALLATION** method, which utilizes the keyhole slots located on the backside of the fixture.

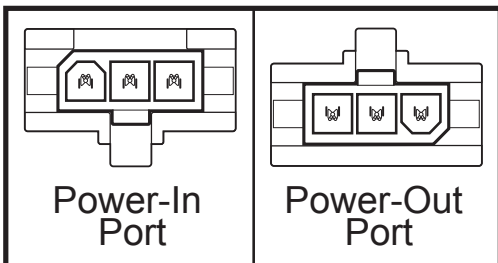

Before mounting, find a suitable location to mount the fixture that will reach the power supply (within 5 feet) or to reach adjoining fixture (within 18 inches). The fixture has two power ports located at each end of the fixture. The “Power-In” port is located on the end next to the on/off switch and is used to connect the fixture to a power supply. The “Power-Out” port is located at the opposite end and is used to link power to additional fixtures connected together.

EASY MOUNTING INSTALLATION

1. The fixture (**A**) can be mounted without utilizing pilot holes. Firmly hold the fixture against the mounting surface and begin turning the mounting screws until they are fully driven in and the fixture is firmly attached to the mounting surface. **NOTE:** DO NOT overtighten the screws, as it may result in damage to the fixture or the mounting surface.

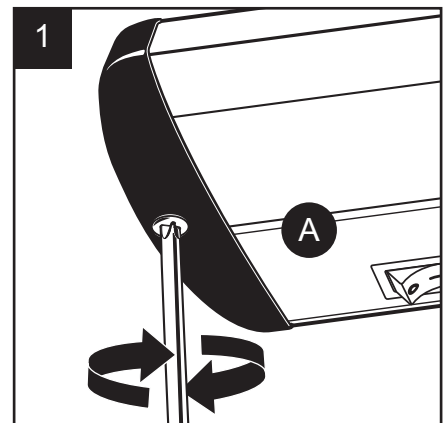

TRADITIONAL MOUNTING INSTALLATION

1. To install the fixture using keyhole slots, place the fixture firmly against the mounting surface and mark the location with a pencil. Measure the distance from the front edge of the fixture to center of the keyhole slots and run a line parallel to the front edge of the cabinet. Mark the desired location of the mounting screws. The center of the screws need to be **6-3/8 in.** apart. Use a 1/16 in. drill bit to drill the pilot holes to aid in the installation of the screws.

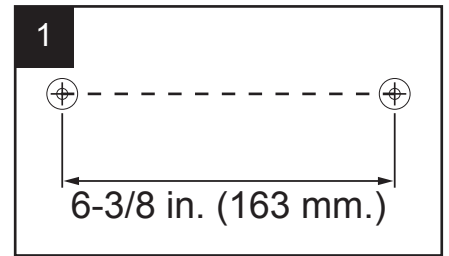

2. Use a nail or awl to dimple the surface to help guide the screws. Either drive the wood screws (**AA**) directly into the surface or drill two 1/16 in. pilot holes to make installing the screws easier. The screws must be driven in straight. Tighten until 3/8 in. of the screws is protruding below the surface.

Hardware Used

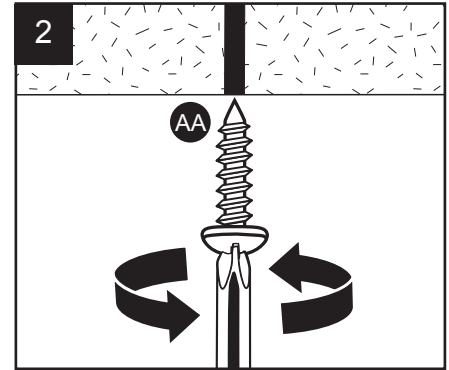

3. Position mounting keyholes over the screws. Slide the fixture until the smaller end of the slot engages the screws. The light fixture should fit tightly against the mounting surface. If the fit is loose, tighten both screws a little more for a secure fit.

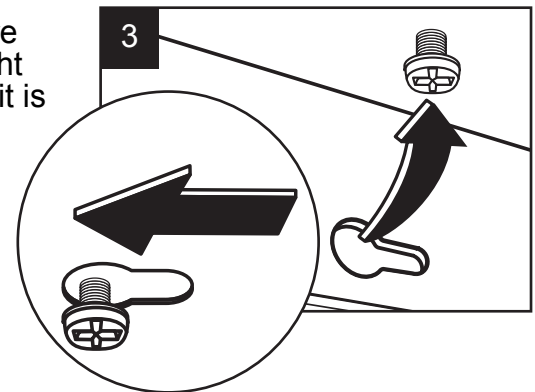

PLUG-IN INSTRUCTIONS

1. Using a flathead screwdriver (not included), carefully pry off the plastic cap that covers the "Power-In" port on the end of the fixture.

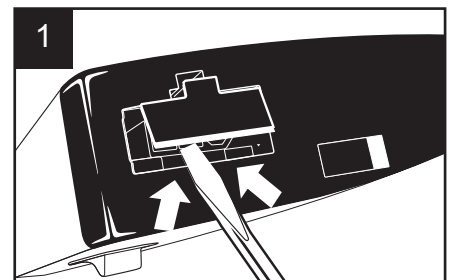

2. **WARNING: DO NOT** plug the power cord into the power supply before completing the installation. The power cord (**B**) has a grounded plug at one end and a connector plug at the other end. **FIRST:** Insert the connector plug into the power port located near the on/off switch at the end of the fixture (**A**). The cord connector plug will **ONLY** fit into this power port. When fully inserted, the catch on the top of the connector plug will click into the power port. **SECOND:** Plug in the power cord into an outlet. Installation is complete.

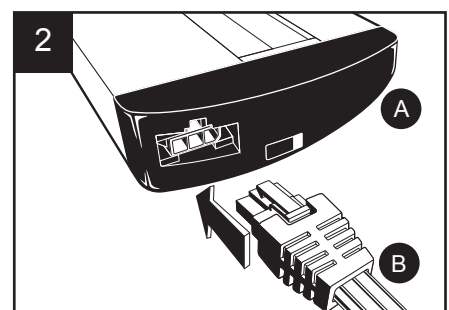

LINKING INSTRUCTIONS

The first fixture is now fully installed and powered. It is now possible to link additional fixtures to this first unit. An 18 inch linking cord (C) has been provided with each fixture. Ensure that the distance between additional fixtures does not exceed the length of the connector cord (18 inches).

Shut off the power to the first fixture, either direct wired or plugged-in to house electrical system, prior to installing the linking cord.

1. Using a flathead screwdriver, carefully pry off the plastic cover that protects the “Power-In” port on the the fixture being added. Carefully pry off the plastic cover that protects the “Power-Out” port on the the fixture it is being linked to.

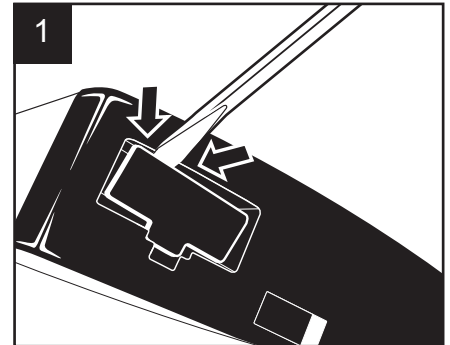

2. Using the same mounting installation method used on the previous fixture, mount the fixture being linked.

3. **NOTE:** The linking cord (C) is fitted with a distinct connector plug at each end. The cord can only connect one way. Try inserting one end of the linking cord into the “Power-Out” port on the fixture installed ahead of the this one. If that fails, try the other end. **DO NOT** force the plugs into either port. When correctly inserted, the plug will insert smoothly and the catch on top of the connector plug will click and lock into place.

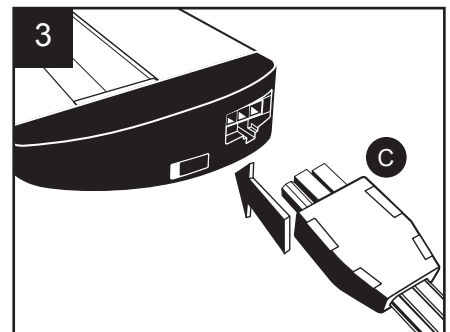

4. Insert the opposite end of the linking cord into the “Power-In” port of the additional unit. **NOTE:** Each light can be individually operated by the on/off switch located on each fixture.

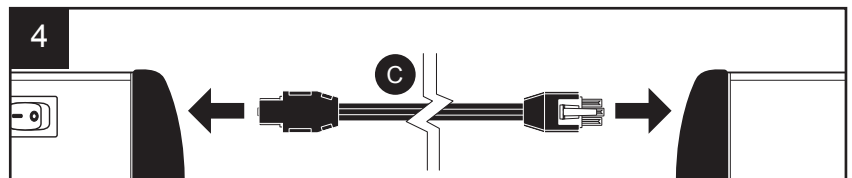

5. Restore power to the powered unit.

CARE AND MAINTENANCE

Periodically clean the fixture using a mild, non-abrasive glass cleaner and soft cloth. Do NOT use solvents or cleaners containing abrasive agents. When cleaning the fixture, make sure the power is turned off. Do not spray liquid cleaner directly onto the LEDs, fixture, diffuser, or wiring.

TROUBLESHOOTING

Minor problems often can be fixed without the help of an electrician. Before doing any work on the fixture, shut off power supply at the circuit breaker panel to avoid electrical shock.

PROBLEM	POSSIBLE CAUSE	CORRECTIVE ACTION
Fixture doesn't light.	<ol style="list-style-type: none">1. Power is off.2. Bad plug connection.3. Bad switch.	<ol style="list-style-type: none">1. Check if power supply is on.2. Check power cord.3. Test or replace switch.
Fuse blows or circuit breaker trips when light is turned on.	<ol style="list-style-type: none">1. Discontinue use.	<ol style="list-style-type: none">1. Call customer service.

WARRANTY

The manufacturer warrants this lighting fixture to be free from defects in materials and workmanship for a period of (5) years from the date of original purchase by the consumer. The fixture is not warranted for use in a commercial or retail application. The warranty is limited to use in a residential environment. We will repair or replace (at our option) the unit in the original color, and style if available, or in a similar color and style if the original item has been discontinued, without charge. Defective units must be properly packed and returned to the manufacturer with a letter of explanation and your original purchase receipt showing date of purchase. **Call 1-866-994-4148** to obtain a Return Authorization number and an address where to ship your defective product. Note: C.O.D. shipments will NOT be accepted. The liability of the manufacturer is in any case limited to replacement of the defective light fixture product. The manufacturer will not be liable for any other loss, damage, labor costs or injury which is caused by the product. This limitation upon the liability of the manufacturer includes any loss, damage, or injury which is (I) to person or property or otherwise; (II) incidental or consequential in nature; (III) based upon theories of warranty, contract, negligence, strict liability, tort, or otherwise; or (IV) directly, or indirectly related to the sale, use, or repair of the product. This warranty gives you specific rights, and you may also have other rights which vary from state to state.

Printed in China

Utilitech & UT Design® and Grounded in Quality® are registered trademarks of LF, LLC. All Rights Reserved.
Other identified trademarks are registered by their respective owners.